

## Orbital welding (Welding power sources)

**AXXAIR**

INNOVATIVE ORBITAL SOLUTIONS

Our range of AXXAIR power supplies has been designed to be user friendly and intuitive. Our step by step design allows, even beginner, to easily generate programs after only a short learning period, while very advanced functions are available to advance users looking to customize their programs.

A particular attention has been paid to using as much as possible standard industrial components for their reliability and availability. The facilitated access to parts makes our power sources robust and easy for maintenance.

The combination of an easy to use and sturdy package allows you to be competitive and makes this range the best choice for all your current or future projects.

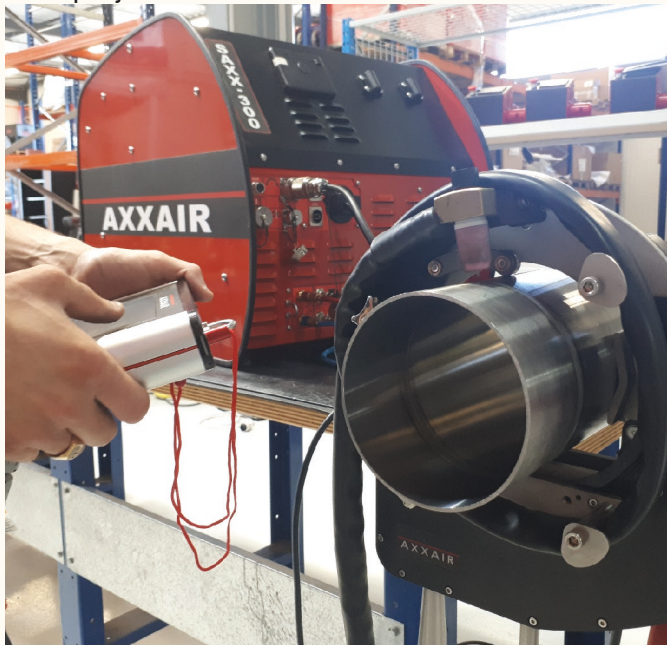

The electronics in charge of piloting the rotors of the welding heads is specifically designed to support various motor type, CD, brushless, stepping motors but also encoders or tachometers, making these power supply one of the most versatile on the market today.

Because our power supply can control most type of motors, we are able to control not only our products but also many of the other products available. Using a 32-pin « quick fit » connector we are able to design several cable adaptor to connect most products available today on our power supply. This great feature allows our customers to use our power supply as a one fits all, reducing the cost of ownership.

### FLEXIBILITY, PRODUCTIVITY

Our latest touch screen interface allows us to make available even the most advanced features in a user friendly and intuitive way.

### QUALITY AND REPEATABILITY

Part of the conviviality of our power supply comes from the innovative way we register a program. First you will create a configuration that includes the model and type of welding head, the tube diameter, the tube wall thickness and the tube material. Then within this configuration you will add you programs, up to 10 per configuration. This makes it really easy to retrieve and select a program even if it was created months ago.

### PORTABILITY

Our power supply are among the easiest to carry on site or move around the workshop, however if you want to be able to move effortlessly the gas cylinder together with the power supply we designed a very convenient trolley.



Please do not hesitate to contact us for all enquiries relating to orbital welding power sources.

We will be glad to share our know-how with you and to devise a solution that best meets your needs!



Join **experience**



# SAXX-210



## Fully-assured gas management

2 separate gas lines, free choice of inerting gas flow management



Gas flow control and flow alarms

Display of the actual flow rate right on the screen

## Water cooled



## Compatible with most closed heads on the market:

AMI, Polysoude, ESAB, Orbitec and Orbitalum

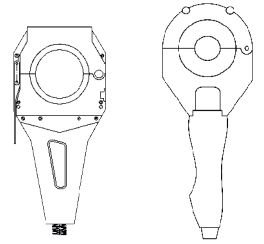

## Interface 5.7 colour touch screen + WiFi

13 languages, possibility of remote control by smartphone or tablet

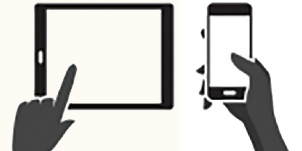

## Integral printer:

Printing program and actual parameters

## Compatible with AVC/OSC system

## PPM sensor

Capable of managing thresholds and sending an electrical pulse to the power source in order to start the welding. This ensures a consistently and properly purged welding area

Records PPM variation during the weld



## Axis for added metal

Possibility of using Step mode

## Data acquisition

Records the last 999 welds on the USB stick

Integrated WeldReport (formatting of the data and presenting of the instructions in the form of DMOS)

## Remove control display

4 m long cable

## USB port on front panel

200 programs per USB stick (possible to use several sticks)

Remote update possible

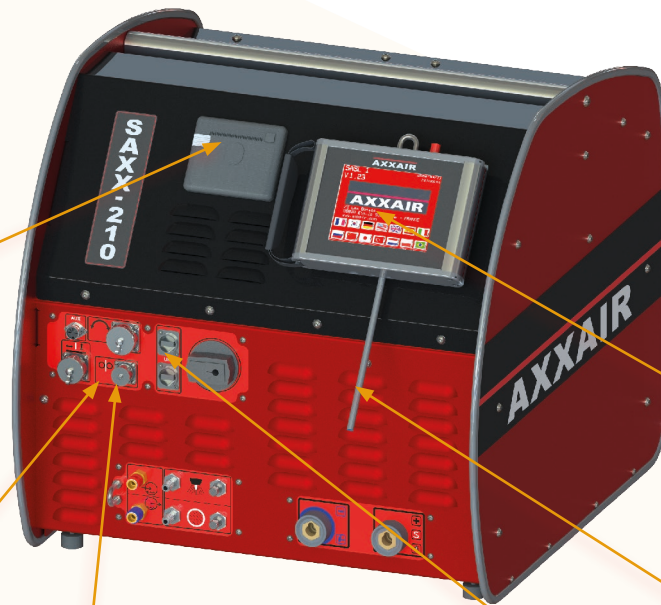



# SAXX-210



## Technical characteristics:

### Duty cycle:

230 V		110 V	
50 %	210 A		
60 %	180 A	60 %	127 A
100 %	160 A	100 %	110 A

### Power supply:

- Single phase network **with earth**
- Supply voltage: 110 to 230 V +/-15%
- Input current consumed 25A at 230V and 32A at 110V
- Frequency: 50 / 60Hz
- Cable supplied: HO7RN-F 3x2.5 mm<sup>2</sup> black length 3m

### Gas supply:

- Maximum inlet pressure: 5 bars
- Maximum flow rate: 50 l / min per gas line
- Inlet connectors: M12x100 male
- Outlet connectors: female blanking union Series 20

### Technology:

- Colour touch screen 5"
- 13 languages
- Up to 16 users with passwords and custom permissions
- Simple and intuitive programming with automatic parameter calculation and programming assistance
- 200 programs in 20 sectors maximum / key

### Intelligence:

- Alarms: More than 30 alarms to protect the system and check that welding is normal.
- Welding voltage measured in increments of 0.1 A
- Minimum pulse time of 50 ms (modifiable via "operator dynamics")

### Integrated printer:

- 32 characters / line
- Print program and actual parameters

### Auxiliary connector:

- Possibility of triggering the welding start via an oxygen meter (dry contact).

### Cooling connector:

- Max pressure: 5 bars
- Cooling power according to standard CEI60974-2: 1.4 kW
- Liquid connectors: female blanking union Series 21

**CAUTION:** The power source is delivered without coolant. See "Consumables" to order the 3 liter can (SACW-C006).

### Wi-fi: (Option)

Remote control of the screen on smartphone or tablet via application, range: 20 to 30 m

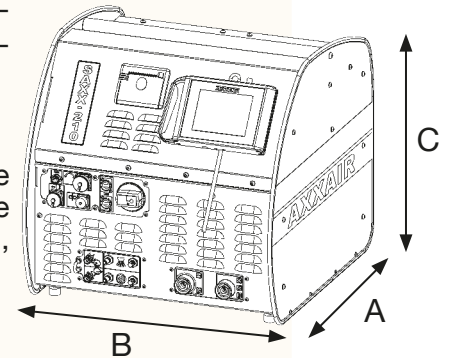

Product code	Description	Two gas lines	Wire feed	Wifi Antenna	AVC/OSC axis	Net weight	Dimensions AxBxC (in mm)
SAXX-210	Orbital TIG power source	x	x			44 kg	562 x
SAXX-210I		x	x	x		44 kg	620 x
SAXX-210OSC	210A, autoline, water cooled	x	x		x	44 kg	545
SAXX-210IOSC		x	x	x	x	44 kg	

All options must be mounted at AXXAIR.



# SAXX-300



## Fully-assured gas management

2 separate gas lines, free choice of inerting gas flow management



Gas flow control and flow alarms

Display of the actual flow rate right on the screen

## Water cooled



## Compatible with most closed head on the market:

AMI, Polysoude, ESAB, Orbitec and Orbitalum

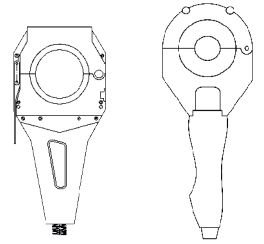

## Interface 5.7 colour touch screen + WiFi (optional)

13 languages, possibility of remote control by smartphone or tablet

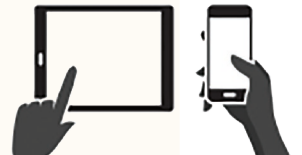

## Integral printer:

Printing program and actual parameters

## Compatible with AVC/OSC system

## PPM sensor

Capable of managing thresholds and sending an electrical pulse to the power source in order to start the welding. This ensures a consistently and properly purged welding area

Records PPM variation during the weld



## Axis for added metal

Possibility of using Step mode

## Data acquisition

Records the last 999 welds on the USB stick

Integrated WeldReport (formatting of the data and presenting of the instructions in the form of DMOS)

## Remove control display

4 m long cable

## USB port on front panel

200 programs per USB stick (possible to use several sticks)

Remote update possible



# SAXX-300



## Technical characteristics:

### Duty cycle:

400 V	
30 %	300 A
60 %	240 A
100 %	210 A

### Power supply:

- Three phase main with earth
- Supply voltage : 400 V +/-15%
- Maximum current on main : 24A
- Frequency : 50/60Hz
- Cable : HO7RN-F 4x2.5 mm<sup>2</sup> black length 3m

### Gas supply:

- Maximum inlet pressure: 5 bars
- Maximum flow rate: 50 l / min per gas line
- Inlet connectors: M12x100 male
- Outlet connectors: female blanking union Series 20

### Technology:

- Colour touch screen 5"
- 13 languages
- Up to 16 users with passwords and custom permissions
- Simple and intuitive programming with automatic parameter calculation and programming assistance
- 200 programs in 20 sectors maximum / key

### Wi-fi: (Option)

Remote control of the screen on smartphone or tablet via application, range: 20 to 30 m



### Intelligence:

- Alarms: More than 30 alarms to protect the system and check that welding is normal.
- Welding voltage measured in increments of 0.1 A
- Minimum pulse time of 50 ms (modifiable via "operator dynamics")

### Integrated printer:

- 32 characters / line
- Print program and actual parameters

### Auxiliary connector:

- Possibility of triggering the welding start via an oxygen meter (dry contact).

### Cooling connector:

- Max pressure: 5 bars
- Cooling power according to standard CEI60974-2: 1.4 kW
- Liquid connectors: female blanking union Series 21

**CAUTION:** The power source is delivered without coolant. See "Consumables" to order the 3 liter can (SACW-C006).

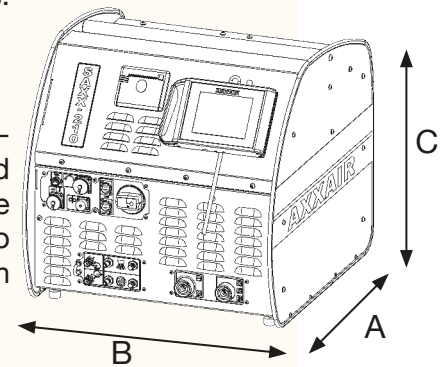

Product code	Description	Two gas lines	Wire feed	Wifi Antenna	AVC/OSC axis	Net weight	Dimensions AxBxC (in mm)
SAXX-300	Orbital TIG power source 300A, 380V, water cooled	x	x			44 kg	562 x 620 x 545
SAXX-300I		x	x	x		44 kg	
SAXX-300OSC		x	x		x	44 kg	
SAXX-300IOSC		x	x	x	x	44 kg	

All options must be mounted at AXXAIR.



## Orbital welding (SAXX) - Accessories

**AXXAIR**

INNOVATIVE ORBITAL SOLUTIONS



Product Code	Description	Net weight	Dimensions (in cm)
SAGC-300	Trolley	55 kg	83 x 56 x 118

Trolley for SAXX-210 and SAXX-300 power sources:

- Module for transporting the SAXX-210 and gas cylinders up to 10.5 m<sup>3</sup>

✓ SAXX-210

✓ SAXX-300

Product Code	Description	Net weight	Dimensions (in cm)
SPPM-10	PPM reader	2 kg	12 x 6 x 15

PPM reader compatible with SAXX power sources:

- Integrated pump
- Trigger threshold adjustment
- Upper and lower tolerance adjustment
- Connected to the SAXX, it only allows welding to be triggered when the threshold is reached. The SPPM-10 guarantees the interior inerting of the tubing and the desired good colouration



Product Code	Description	Net weight	Dimensions (in cm)
SPPM-C10	Extension cable for SPPM-10	0.5 kg	40 x 59 x 25 cm

10 meter-extension cable for SPPM-10 (PPM reader)

✓ SAXX-210

✓ SAXX-300

Product Code	Description	Net weight	Dimensions (in cm)
SAFS-G01	Gas splitter pipe	0.2 kg	22 x 22 x 22

Gas splitter pipe:

- For connecting the back and front purge gas to the same cylinder. To be used in combination with a pressure regulator for an industrial gas cylinder.



✓ SAXX-210

✓ SAXX-300





NEW

# Accessoires SAXX Commutateur



**AXXAIR**  
INNOVATIVE ORBITAL SOLUTIONS

You have repeatable welds to perform and you want to **optimize the cycle time** of your welding operations to be **more efficient** and **increase productivity**?

The new AXXAIR Switch Box is the ideal response!

The Switchbox allows it to use two welding machines with one only orbital welding power source of the SAXX series and to use the two machines alternatively.

The parts that need to be welded can be positioned in one of the two machines while the other one is making a weld. The preparation and setting up time of the parts is thus optimized.

Once the weld is finished, the weld on the other machine can directly be started. The welded parts can be removed from the first machine and new parts can be placed in this machine.

### Switch button

The green LED indicates if switching is possible. Switching is done either by this button, or by the start button of the inactive machine



### Led lights

Indicate which machine is selected

**Significant time saving**, avoiding the simultaneous purchase of two welding power sources

**Cost reduction**

**Intuitive and efficient use thanks to the SAXX interface**

### Flexibility

- Use of manual torches and ppm reader (SPPM-10)
- Use of two gas lines (depending on options chosen in the SAXX)
- Use of two wire dispensers with 2 machines (depending on options chosen in the SAXX)

### Compatibility

Use of **all welding machines** compatible with the SAXX power sources \*

**Possibility of using 2 different machines with 2 different programs**

### Two gas lines for each machine

(depending on options chosen in the SAXX)

Gas flow adjustment wheels for each connected machine

SAXX connection

Connection for a welding machine

Connection for a second welding machine

**U bolt common for both machines**

\* excluding AVC/OSC systems



NEW

# Accessoires SAXX Commutateur



**AXXAIR**  
INNOVATIVE ORBITAL SOLUTIONS



**Technical characteristics:**

- Power supply 110-230V
- 50-60 Hz (3m cable), 1,9 A max
- Max. welding current: 300A
- Length of the cables between the SASW-DGW and the SAXX: 1,5m
- Cooling circuit common to both machines
- Integrated carry handle
- Possible use of cable extensions (see accessories of welding machines) between the machines and the switchbox between the switchbox and the SAXX
- Version of the SAXX software: V2.40 or higher

- The use of two gas lines is integrated in the SASW-DGW, to be able to use it:  
The option «**Second gas line**» must be chosen in the SAXX power source
- The use of wire for one or two machines (two wire feeders can be used):  
The option «**Wire feed**» must be chosen in the SAXX power source

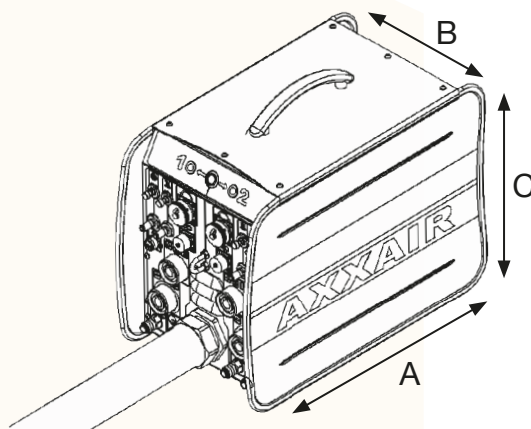

Product Code	Description	Net weight	Dimensions (AxBxC)
SASW-DGW	Switchbox	13 kg (with cables)	467 x 247 x 385 mm

**Compatible with:**

- SATF (SATF-M, SATF-ND and SATF-MI), SATO (SATO-M, SATO-ND and SATO-E), SX, SATP, SXMF
- AML models 8, 9 and 95, Polysoude : UHP, MW and MU IV, Orbitalum : Orbiweld and Orbiweld S, ESAB : PRB, Orbitec : OSW

Product Code	Description
SASW-CCO	Coupling pipe cooling circuit for Switchbox

Allows to control 2 machines with different cooling circuits

✓ SAXX-210

✓ SAXX-300

Join **experience**





## Orbital welding (SAXX) - Accessories

**AXXAIR**

INNOVATIVE ORBITAL SOLUTIONS

If you have an AMI orbital welding head, model 8 or 9, you can use them with our SAXX power sources.

To connect the heads to our SAXX power sources, you need an adapter kit. Please choose the kit according to the AMI power source that you have acquired with this head.



Product Code	Description	Net weight	Dimensions
SAFS-ADAMI1	Adapter kit	1.2 kg	l : < 40 cm

Adapter kit for connecting the following heads to SAXX power sources:

- AMI Models 8 and 9, initially connected to the AMI power sources 205, 207, 217 and 217P
- AXXAIR's closed heads SATF-xxMI and SATF-xxMIH

✓ SAXX-210

✓ SAXX-300

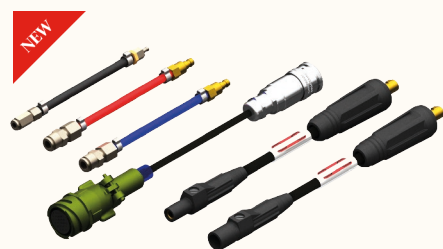

Product Code	Description	Net weight	Dimensions
SAFS-ADAMI2	Adapter kit	1.3 kg	l : < 40 cm

Adapter kit for connecting the following heads to SAXX power sources:

- AMI Models 8 and 9, initially connected to the AMI power source 307

✓ SAXX-210

✓ SAXX-300



Product Code	Description	Net weight	Dimensions
SAFS-ADAMI3	Adapter kit	1.3 kg	l : < 40 cm

Adapter kit for connecting the following heads to SAXX power sources:

- AMI Models 8 and 9, initially connected to the AMI power sources 227, 327 and 415

✓ SAXX-210

✓ SAXX-300



# Orbital welding (SAXX) - Accessories



If you have an orbital welding head from another brand and you want to use it with our SAXX power sources, please refer to the adaptation kits below.



Product Code	Description	Net weight	Dimensions
SAFS-ADORB11	Adapter kit	1.2 kg	L < 50 cm

Adapter kit for connecting the following heads to SAXX power sources:

- Orbitalum ORBITALWELD models : ORBIWELD38S, ORBIWELD76S and ORBIWELD115S

✓ SAXX-210

✓ SAXX-300

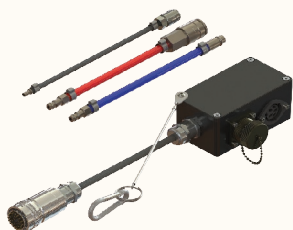

Product Code	Description	Net weight	Dimensions
SAFS-ADPOLY1	Adapter kit	0.9 kg	L < 50 cm

Adapter kit for connecting the following heads to SAXX power sources:

- MW Polysoude models (MW40, MW 65, MW115, MW170, MU IV 38, MU IV 115, UHP250, UHP500 and UHP1500)

✓ SAXX-210

✓ SAXX-300



Product Code	Description	Net weight	Dimensions
SAFS-ADORBITEC	Adapter kit	0.3 kg	L < 50 cm

Adapter kit for connecting the following heads to SAXX power sources:

- Orbitec models: OSW40, OSW80 and OSW170

✓ SAXX-210

✓ SAXX-300



Product Code	Description	Net weight	Dimensions
SAFS-ADESAB	Adapter kit	0.5 kg	L < 50 cm

Adapter kit for connecting the following heads to SAXX power sources:

- ESAB models: PRB17-49, PRB33-90 and PRB60-170

✓ SAXX-210

✓ SAXX-300



# Orbital welding (SAXX) - Accessories



Product Code	Description	Net weight	Dimensions (in cm)
SAFS-AD01	Adaptor	0.411 kg	l : < 35 cm

Adaptors for connecting the following AXXAIR welding heads to our former **SASL** power sources:

- SATF-xxNDX
- SATF-xxNDHX
- SATO-xxE41 - SATO-xxE42 - SATO-xxE43 - SATO-xxE44

✓ SASL-xxx



Product Code	Description	Net weight	Dimensions (in cm)
SAFS-AD02	Adaptateur	0.48 kg	l : 35 cm

Adaptors for connecting the former generation of AXXAIR welding heads to **SAXX** power sources:

- SATF-xxND
- SATO-xxE01 et SATO-xxE02

✓ SAXX-210

✓ SAXX-300

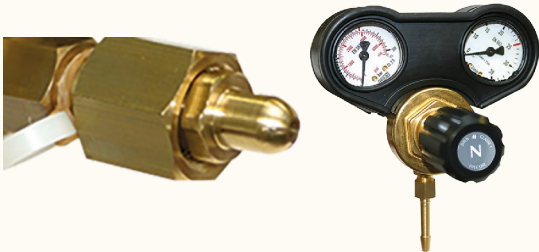

Product Code	Description	Net weight	Packaging (in cm)
SAMD-NL	Pressure regulator	1.1kg	16 x 14.5 x 17

Pressure regulator 30 l / min compatible with:

- Finland, Netherlands, Sweden, Denmark

✓ SAXX-210

✓ SAXX-300



Product Code	Description	Net weight	Packaging (in cm)
SAMD-FR	Pressure regulator	1.1kg	16 x 14.5 x 17

Pressure regulator 30 l / min compatible with:

- Algeria, Angola, France, Greece, Syria, Tunisia, Sudan, Lebanon, Morocco, Portugal, Gabon, Ivory Coast, Senegal, Chad, Mauritania, Congo, Guinea, Mali, Belgium

✓ SAXX-210

✓ SAXX-300





# Orbital welding (SAXX) - Accessories



Product Code	Description	Net weight	Packaging (in cm)
SAMD-AL	Pressure regulator	1.1kg	16 x 14.5 x 17

Pressure regulator 30 l / min compatible with:

- Germany, Austria, Bosnia Herzegovina, Croatia, Hungary, Israel, Switzerland, Macedonia, Montenegro, Poland, Serbia, Slovenia, Korea, Czech Republic

✓ SAXX-210

✓ SAXX-300



Product Code	Description	Net weight	Packaging(in cm)
SAMD-UK	Pressure regulator	1.1kg	16 x 14.5 x 17

Pressure regulator 30 l/min compatible with:

- South Africa, Saudi Arabia, Brunei, Egypt, United Arab Emirates, Hong Kong, India, Singapore, Yemen, Indonesia, Iraq, Ireland, Jordan, Kuwait, Liberia, Libya. Sri Lanka, Malaysia, Malta, New Zealand, Nigeria, Pakistan, Peru, United Kingdom, Vietnam

✓ SAXX-210

✓ SAXX-300



Product Code	Description	Net weight	Dimensions (in cm)
SATMX-E	TIG Manual torch	2.1kg	22 x 22 x 22

TIG Manual torch **water cooled:**

- Allows manual tacking and welding with the SAXX power sources

✓ SAXX-210

✓ SAXX-300



Product Code	Description	Net weight	Dimensions (in cm)
SADF2X	Wire dispenser	12 kg	59.7 x 38.4 x 24

Wire feeder for SAXX, cable sheath 5 m max:

- Supplied with SAXX power supply-connection cable and teflon sheath to guide the wire
- Drive pressure adjusted by adjustable spring, with handle.

✓ SAXX-210

✓ SAXX-300



# Orbital welding (SAXX) - Consumables



Product Code	Description	Net weight	Packaging (in cm)
SACW-CO06	Cooling liquid	3.3kg	15 x 15 x 27

Cooling liquid (3l container).

The cooling is not directly delivered with the power source.

✓ SAXX-210

✓ SAXX-300



Product Code	Description	Net weight	Packaging (in cm)
SIMP-02	Printer rolls	0.7kg	29 x 9.5 x 5

Rolls for integrated printer (set of 10)

✓ SAXX-210

✓ SAXX-300

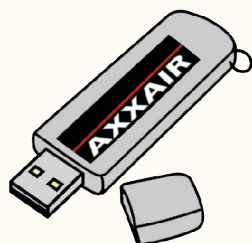

Product Code	Description	Net weight	Packaging (in cm)
SUSBX210	USB stick	0.02kg	6 x 2 x 1

USB stick for **SAXX-210**:

USB stick with software for recording welding programmes and the WeldReport

✓ SAXX-210

SAXX-300

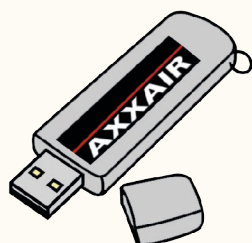

Product Code	Description	Net weight	Packaging (in cm)
SUSBX300	USB stick	0.02kg	6 x 2 x 1

USB stick for **SAXX-300**:

USB stick with software for recording welding programmes and the WeldReport

SAXX-210

✓ SAXX-300

